

NOTES:

1. SUBSTRATE: IR GRADE FUSED SILICA
2. COATING:  
S1 & S2: R(AVG) ≤ 0.5% FROM 350-700nm @ 0° AOI
3. CENTERING: < 3 ARCMIN
4. RoHS: COMPLIANT

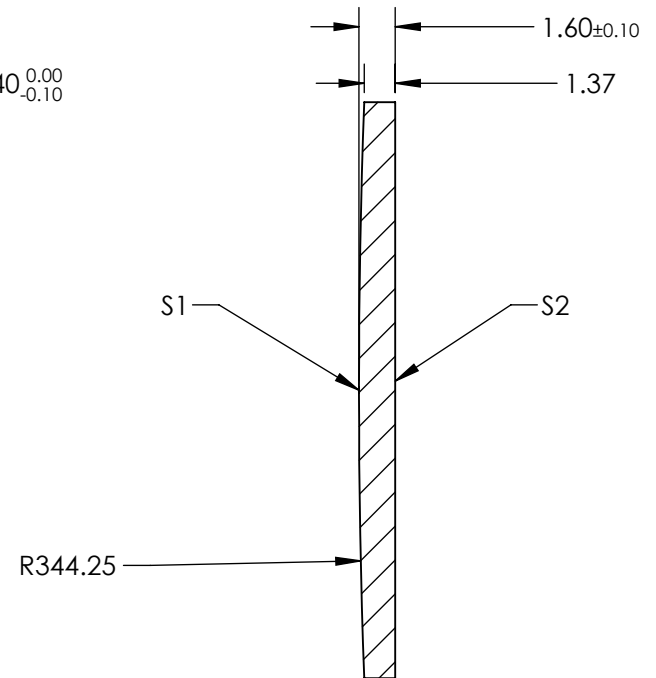
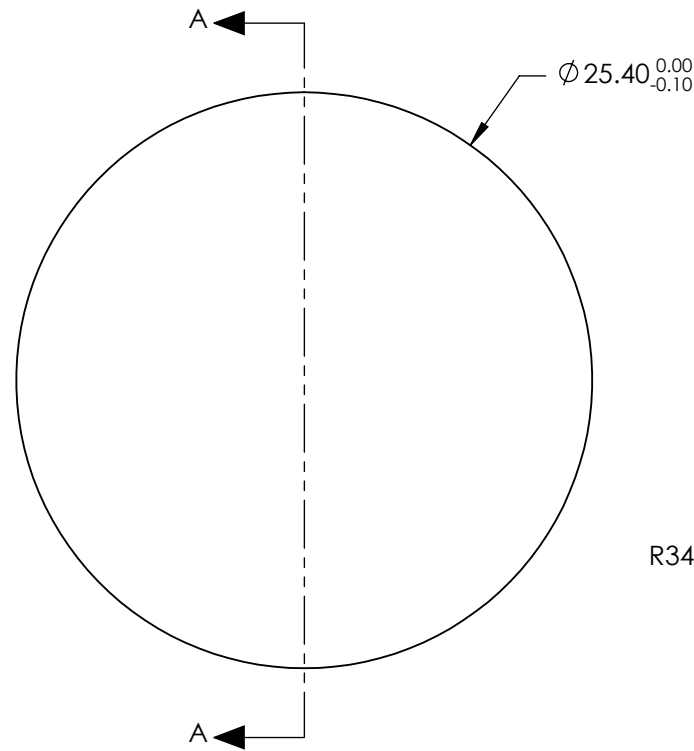
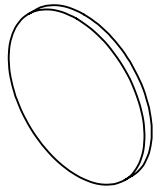

SECTION A-A

**FOR INFORMATION ONLY:  
DO NOT MANUFACTURE  
PARTS TO THIS DRAWING**

SPECIFICATIONS SUBJECT TO CHANGE WITHOUT NOTICE  
DIMENSIONS ARE FOR REFERENCE ONLY

	S1	S2
SHAPE	CONVEX	PLANO
SURFACE QUALITY	20-10	20-10
CLEAR APERTURE	Ø22.86	Ø22.86
BEVEL	PROTECTED AS NEEDED	PROTECTED AS NEEDED



ALL DIMS IN

mm

**EO**® **Edmund Optics**®

TITLE

25.4mm Diameter x 750mm FL, 350-700nm,  
Ultrafast Thin PCX Lens

DWG NO

22648

SHEET  
16 OF 19