

FOR INFORMATION ONLY:
DO NOT MANUFACTURE PARTS TO THIS DRAWING

SPECIFICATIONS SUBJECT TO CHANGE WITHOUT NOTICE
 DIMENSIONS ARE FOR REFERENCE ONLY
 DIMENSIONS ARE IN mm [INCHES]

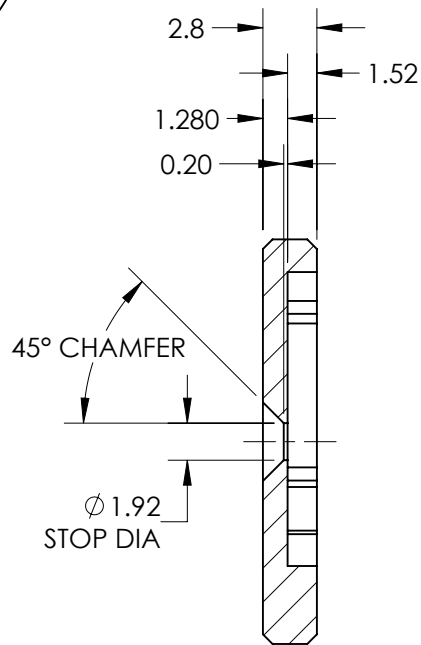

SECTION A-A

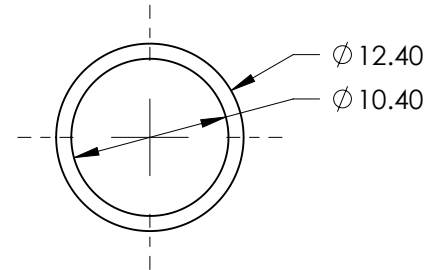
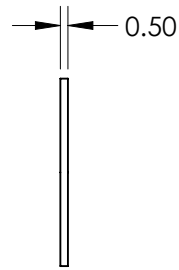
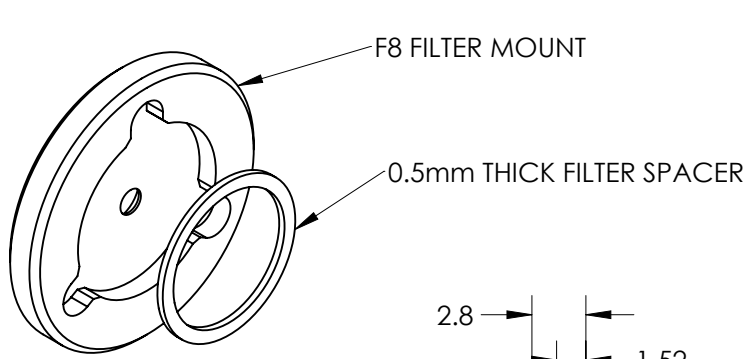
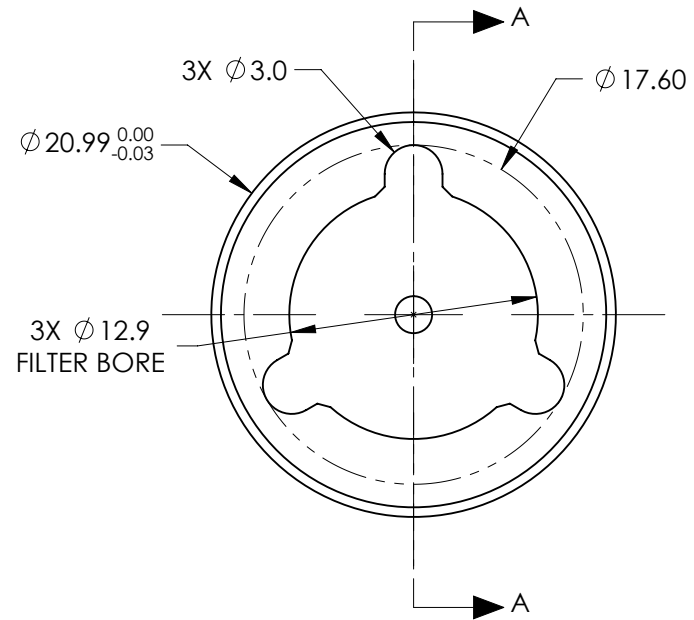

EO® **Edmund Optics**®

TITLE	F8.0 FILTER MOUNT ASSEMBLY FOR 12mm Cx LENS	
DWG NO	33598	SHEET 1 OF 1